

AVN 224S: SUT valve actuator

How energy efficiency is improved

Automatic adaptation to valve, precision activation and high energy efficiency with minimal operating noise

Features

- Combination with VUG and BUG flanged valves
- AVN224SF232 with safety function (as per DIN EN 14597) in combination with VUP flanged valve and normally closed (NC) version
- Actuating power 1100 N
- For controllers with constant output (0...10 V or 4...20 mA) and switching output (2-point or 3-point control)
- Stepping motor with SAUTER Universal Technology (SUT) electronic control unit and electronic, force-dependent cut-off
- Simple assembly with valve; spindle is automatically connected after control voltage is applied (patented system)
- Control signals (constant or switching) are automatically detected and indicated via two LEDs
- Coding switches for selecting characteristic and running time
- Type of characteristic curve (linear/quadratic/equal-percentage) can be set on the actuator
- Automatic stroke adaptation (valve stroke 8...49 mm). Saved stroke is not lost even in the event of power failure
- Direction of operation can be selected via screw terminals when making the electrical connection
- Push-buttons on outside of housing for manual adjustment with motor cut-off and as trigger for re-initialisation
- Can be combined with valves from various manufacturers with optional adapter accessories
- Maintenance-free gear unit made of sintered steel; gearbox base-plate made of steel
- Spring pack and mounting column made of stainless steel; mounting bracket made of cast light alloy for valve fitting
- AVN224SF232 with TÜV certification
- Three break-out cable inlets

The following features and certifications do **not** apply to the United Kingdom of Great Britain and Northern Ireland (UK):

- AVN224SF232 in combination with VUP
- TÜV certification

The product is not designed for use in the United Kingdom.

Technical data

Power supply

Power supply 24 VAC	±20%, 50...60 Hz
Power supply 24 VDC	±15%
Power supply 230 VAC	±15%, 50...60 Hz (with accessories)
Power consumption	10 W/18 VA at 24 VAC/DC 11 W/24VA at 230 VAC (with accessories)

Parameters

Running time of motor	2/4/6 s/mm
Running time of spring ¹⁾	15...30 s
Actuating power	1100 N
Number of spring returns	> 40 000
Response time for 3-point	200 ms

Positioner

Control signal 1	0...10 V, R _i = 100 kΩ
Control signal 2	4...20 mA, R _i = 50 Ω
Position feedback signal	0...10 V, load > 10 kΩ
Starting point U ₀	0 V or 10 V
Control span ΔU	10 V

¹⁾ Spring return time equates to a stroke of 14...40 mm and does not depend on the set running time



AVN224SF132



AVN224SF132



AVN224SF232

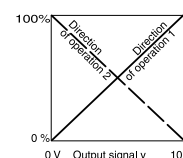

ValveDim app



Switching range X_{Sh}	300 mV
--------------------------	--------

Ambient conditions

Ambient temperature	-10...55°C
Ambient humidity	< 95% rh, no condensation
Media temperature	Max. 130°C

Construction

Housing	Two-part, yellow
Housing material	Flame-retardant plastic
Cable inlet	2 pcs. M20 × 1.5 1 pc. M16 × 1.5
Connection terminals	Screw terminals, max. 2.5 mm ²
Dimensions W × H × D	230 × 289/382 × 133 mm (height depends on type)
Weight	5.6 kg

Standards, directives

Type of protection	IP66 (EN 60529)
Protection class	III (IEC 60730)
Over-voltage categories	III
Degree of contamination	III

CE conformity according to

EMC Directive 2014/30/EU ²⁾	EN 61000-6-2, EN 61000-6-4
Low-Voltage Directive 2014/35/EU	EN 60730-1, EN 60730-2-14
PED 2014/68/EU, cat. IV ³⁾	Category IV, fluid group II, liquid or steam pressure Modules B+D

Overview of types

Type	Voltage	Direction of operation of spring	Certification
AVN224SF132	24 VAC/DC	Spindle retracted	-
AVN224SF132-5	24 VAC/DC	Spindle retracted	-
AVN224SF132-6	24 VAC/DC	Spindle retracted	-
AVN224SF232	24 VAC/DC	Spindle extended	TÜV

☀ AVN224SF132: valve normally closed (NC) with VUG and BUG; valve normally open (NO) with VUP

☀ AVN224SF232: valve normally open (NO) with VUG and BUG; valve normally closed (NC) with VUP (as per DIN EN 14597)

Accessories

Type	Description
0313529001	Split-range unit for setting sequences

Modules can be added for 2-point/3-point and continuous control; additional power 2 VA

Type	Description
0372332001	230 V ±15%, supply voltage
0372332002	100 V ±15%, supply voltage

Auxiliary change-over contacts (2 each) 12...250 VAC

Type	Description
0372333001	Auxiliary change-over contacts (sets of 2), 12...250 VAC, infinitely variable, min. 100 mA and 12 V permissible load 6(2) A
0372333002	Auxiliary change-over contacts (sets of 2), 12...250 VAC, gold-plated contacts, from 1 mA, to max. 30 V, wider range 3(1) A

Potentiometer

Type	Description
0372334001	Potentiometer, 2000 Ω, 1 W, 24 V
0372334006	Potentiometer, 1000 Ω, 1 W, 24 V

²⁾ EN 61000-6-2: HF immunity, limitation of feedback signal between 80 MHz and 1000 MHz criterion B, otherwise criterion A

³⁾ Only AVN224SF232 in combination with VUP flanged valve. See product data sheet for valve

Adapters for high temperatures

Type	Description
0372336180	Intermediate piece (required when temperature of the medium is 130...180 °C)
0372336240	Adapter (required when temperature of the medium is 180...200 °C)

Mounting set for AVN224SF*32 onto SAUTER valves (no adapter needed for 0372338002)

Type	Description
0372338001	V/B6 to DN 50, V/BXD, V/BXE, to DN 50, stroke 14 mm
0372338002	V/B6 DN 65...150, V/BXD, V/BXE from DN 65, stroke 40 mm
0372338003	Conversion kit from AV*2*4SF132-5 to standard actuator AV*2*4SF132
0372338004	Conversion kit from AV*2*4SF132-6 to standard actuator AV*2*4SF132

Adapter set for non-SAUTER valves

Type	Description
0372376010	Siemens with 20 mm stroke or 10 mm spindle diameter
0372376014	Siemens with 40 mm stroke or 14 mm spindle diameter
0372377001	Johnson Controls DN 15...150, 14, 25, 40 mm stroke, spindle diameter 10, 12, 14 mm
0372378001	Honeywell with 20 mm stroke
0372378002	Honeywell with 38 mm stroke
0372386001	LDM type RY113 R/M
0372389001	ITT-Dräger, DN 15...32
0372389002	ITT-Dräger, DN 40...50
0378263001	End stop (needed for V/BXD, V/BXE DN 15...50, V/B6 DN 15 with kvs ≤ 1 m³/h)
0386263001	Cable gland M16 × 1.5
0386263002	Cable gland M20 × 1.5
0372387001	SAUTER Satchwell VZF1727 mounting set
0372461001	Forced operation for AVx2xS
0510390052	Adapter set for non-SAUTER valves (Frese), stroke 20 mm
0510390053	Adapter set for non-SAUTER valves (Frese), stroke 40/43 mm

 Adapter: Not needed for version AVN224SF132-6

 Potentiometer 130 Ω: This potentiometer must only be used as a voltage divider

Description of operation

This valve actuator may only be used for actuating 2- or 3-way valves from SAUTER or with non-SAUTER valves compatible with the adapter set. Other applications are not permitted.

After a restart or a start after triggering of the emergency function (terminal 21), there is a waiting time of up to 45 seconds until the actuator is available again. Depending on the type of connection (see connection diagram), the actuator can be used as a continuous (0...10 V or 4...20 mA), 2-point (Open/Close) or 3-point (Open/Stop/Close) actuator.

The running time of the actuator can be set with switches S1 and S2 according to the relevant requirements. Switches S3 and S4 are used to configure the characteristic (equal-percentage, linear or quadratic).

The external pressure switches enable manual positional setting. This only functions if the emergency function (terminal 21) is electrically connected and power is supplied. When one of the two push-buttons is pressed for 5 seconds, the actuator switches to manual operating mode. Both LEDs flash red/green. When a push-button is pressed (Open/Close), the actuator moves in the corresponding direction. When a button is pressed again, the actuator stops. However, when a button is pressed for at least 5 seconds, the actuator switches to control mode. If an emergency function is performed during manual operation, the emergency function has priority. After an emergency function, the actuator is always in control mode.

Intended use

This product is only allowed to be used in HVAC building systems for control and regulation purposes. Other uses require the prior consent of the manufacturer.

The section "Description of operation" and all product instructions in this data sheet must be observed.

Modifying or converting the product is not permitted.

The valves are suitable for control functions.

Improper use

The valve actuator is not suitable for:

- Use in the United Kingdom of Great Britain and Northern Ireland (UK)
- Transport applications and use at altitudes above 2000 metres
- Use in areas where there is a risk of condensation
- Use in plants with high pressure surges



Notice in accordance with California Proposition 65

The product contains lead. To be marketed in North America, the appropriate warnings must be affixed to the product or packaging.

Engineering and fitting notes



NOTICE!

Connection and fitting may only be carried out by an authorised electrician. The regulations and rules of electrical installation must be observed.

The actuator is mounted directly on the valve and fixed with screws (no further adjustments are required). The actuator is connected with the valve spindle automatically. Depending on the type and how it is delivered ex works, the stroke of the actuator spindle is 0% or 100%.

The housing contains three break-out cable inlets which are broken out automatically when the cable inlet is screwed in.

The concept of DC motor/electronics enables parallel operation of multiple valve actuators of the same type. The cross-section of the power cable must be selected based on the cable length and the number of actuators. With five actuators wired in parallel and a cable length of 50 m, we recommend a cable cross-section of 1.5 mm² (power consumption of the actuator × 5).

The maximum equipment for the actuator is one 230 V module, one additional accessory component (auxiliary contact or potentiometer) and the split-range unit.



Note

Extreme pressure surges in the system can lead to gear damage and must be prevented by using anti-surge valves.

Fitting position

Do not mount the actuator suspended under the valve. The device could be damaged by the ingress of condensate or dripping water.

Outdoor fitting

If fitted outside buildings, the devices must be additionally protected from the weather.

Dismantling and disposal



WARNING!

Eye injury due to spring escaping.

►Wear safety goggles when opening and disassembling the device. The built-in spring is preloaded.

The local, currently valid laws must be observed when disposing of the device.

You will find more information on the materials and substances in the Declaration on materials and the environment for this product.

Additional information

Fitting instructions for AVN 224S	0505927033
Product data sheet for VUG	PDS 56.120
Product data sheet for BUG	PDS 56.121
Product data sheet for VUP	PDS 56.122
Declaration on materials and the environment	MD 51.379





LED indicator

The following operating statuses are shown:

In automatic mode

Status	Indicator/display	Description
Both LEDs flashing red		Initialisation
Top LED steady red		Top limit stop or "Closed" position reached
Bottom LED steady red		Bottom limit stop or "Open" position reached
Top LED flashing green		Actuator is running, moving to "Closed" position
Top LED steady green		Actuator is stopped, last direction of travel "Closed"
Bottom LED flashing green		Actuator is running, moving to "Open" position
Bottom LED steady green		Actuator is stopped, last direction of travel "Open"
Both LEDs steady green		Waiting time after switching on or after the emergency function
Both LEDs off		No power supply (terminal 21)

In manual mode

Status	Indicator/display	Description
Top LED steady red Bottom LED alternately red and green		Top limit stop or "Closed" position reached
Top LED alternately red and green Bottom LED steady red		Bottom limit stop or "Open" position reached
Top LED flashing green Bottom LED alternately red and green		Actuator is running, moving to "Closed" position
Top LED alternately red and green Bottom LED flashing green		Actuator is running, moving to "Open" position
Both LEDs flashing red		Actuator is stopped

Initialisation and feedback signal

The actuator does not initialise itself autonomously. Voltage must be connected to terminals 1 and 21, and then the manual mode must be activated (see description of operation). First the valve spindle must be coupled with the actuator spindle. This is performed by moving the actuator spindle out until the closing mechanism snaps in. With the NO version, the initialisation and the assembly with the valve can only be carried out if the working spindle has first been retracted.

Once the actuator is connected to the valve, the safety screw must be fitted in the locking ring. When the safety screw is fitted, a manual initialisation must be triggered. To do this, the two push-buttons must be pressed for at least 5 seconds. The actuator then moves to the lower limit stop of the valve. Then it moves to the upper limit stop. The distance is measured and stored by a travel measurement system. The control signal and the feedback are adapted to this effective stroke. After a power failure or an emergency function, no re-initialisation is carried out. The values remain saved.

During initialisation, the feedback signal is inactive or equal to the value "0". Initialisation is carried out with the shortest running time. The initialisation is only valid when the whole process is completed without an interruption. Pressing a push-button interrupts this process.

If the valve actuator detects jamming, it will report this by setting the feedback signal to 0 V after about 90 s. During this time, the actuator tries to overcome the jamming. If the jamming can be overcome, the normal control function is activated again. The feedback signal is present again.

Safety function or emergency function (AVN224SF232)

The AVN224SF232 actuator and its safety function conform to DIN EN 14597 in combination with VUP valves. If the power supply fails or is switched off, or if a monitoring contact (STB/SDB) is activated, the brushless DC motor releases the gear unit and the preloaded spring moves the actuator to the end position. In the process, the control function of the actuator is locked for 45 seconds so that the end position can definitely be reached. Both LEDs light up while it is locked.

The reset speed is controlled using the motor so that no pressure surges can occur in the power cable. The brushless DC motor generates the holding force, acts as a brake with its integrated eddy current brake and serves as a motor for the control function. After an emergency function, the actuator does not re-initialise itself.



Note

Actuators with safety functions must be checked regularly for operability by means of a test run. If damage can occur due to the failure of the control unit, additional protective measures must be implemented.

Connection as 2-point valve actuator (24 V)

This actuation (Open/Close) can be performed via two wires. The voltage is applied to terminals 1, 2a and 21. When voltage (24 V) is applied to terminal 2b, the actuator spindle moves out. After this voltage is switched off, the actuator moves to the opposite end position. In the end positions (valve limit stop or maximum stroke reached) or in the case of an overload, the electronic motor cut-off is activated (no limit switches).

The running times can be set using the coding switch. The characteristic cannot be selected here (the result is the characteristic of the valve). The feedback signal is active as soon as the initialisation has been performed and there is a voltage on terminal 21. Terminals 3i and 3u must not be connected.

Connection as 3-point valve actuator (24 V)

The valve can be moved to any desired position by applying voltage to terminals 2b (or 2a) and 21. If voltage is applied to terminals 1 and 2b, the actuator spindle moves out and opens the valve. It moves in and closes the valve when the electrical circuit is closed via terminals 1 and 2a.

In the end positions (valve limit stop or maximum stroke reached) or in the case of an overload, the electronic motor cut-off is activated (no limit switches). The direction of the stroke can be changed by swapping the connections.

The running times are set using the coding switch. The characteristic cannot be selected here (the result is the characteristic of the valve). The feedback signal is active as soon as the initialisation has been performed and there is a voltage on terminal 21. Terminals 3i and 3u must not be connected.

Connection with 230 V or 100...110 V as 2-point/3-point or with continuous control of valve actuator (accessory 0372332)

The accessory module is plugged into the connection area and then connected as required. During commissioning, the actuator must be initialised manually together with the valve. The running times can be selected using the coding switch on the baseboard. The characteristic can only be selected for continuous control. The characteristic of the valve is decisive.

A switch is integrated into the module which is automatically moved to the correct position when the module is being installed. In this application, the switch lever is in the top position.

The accessory module is not suitable for 2-point actuation.

Connection to a control voltage (0...10 V or 4...20 mA)

The built-in positioner controls the actuator depending on controller's output signal y.

A voltage signal (0...10 V $-$) at terminal 3u or a current signal at terminal 3i serves as the control signal. If there is a control signal on both terminals (3u (0...10 V) and 3i (4...20 mA)) at the same time, the input with the higher value has priority.

Direction of operation 1 (mains power supply on internal connection 2a):

When the positioning signal is increasing, the actuator spindle extends.

Direction of operation 2 (mains power supply on internal connection 2b):

When the positioning signal is increasing, the actuator spindle retracts.

The starting point and control span are fixed. A split-range unit (only for voltage input 3u) designed for installation in the actuator is available as an accessory for adjusting partial ranges (see split-range unit function).

After the connection of the power supply and the initialisation, the actuator moves to every valve stroke between 0% and 100%, depending on the control signal. Thanks to the electronics and the travel measurement system, no stroke is lost and the actuator does not require periodic re-initialisation. When the end positions are reached, this position is checked, corrected if necessary, and saved again. It is thus possible to operate multiple actuators of the same type in parallel. The feedback signal $y_0 = 0...10$ V corresponds to the effective valve stroke of 0 to 100%.

If the control signal 0...10 V or 4...20 mA is interrupted in direction of operation 1, the actuator spindle retracts completely, or extends completely in direction of operation 2.

The coding switch can be used to set the characteristic of the valve: Linear, equal-percentage or quadratic. This characteristic can only be generated when the actuator is used as a continuous actuator. Additional switches can be used to select the running times (with the 2-point, 3-point or continuous functions). Continuous control can also be used with a power supply of 230 V or 110 V (accessory required). You must ensure that the neutral wire of the controller is connected to the control voltage. The neutral wire of the power supply may only be used for the module.

Valve design



SAUTER provides various tools for valve design and engineering:

- ValveDim smartphone app
- ValveDim PC program
- ValveDim slide rule

You can find the tools under the link www.sauter-controls.com/en/performance/valve-calculation/ or scan the QR code



Split-range unit (accessory 0313529)

This accessory can be built into the actuator or externally housed in an electrical junction box.

Starting point U_0 and control span ΔU can be set with the potentiometer. In this way, several control units can be operated in sequence or cascade by the control signal of the controller. The input signal (partial range) is converted into an output signal of 0...10 V.

Design and materials

The yellow housing, consisting of the front part, rear part and connecting lid, only serves as a cover. The push-buttons for manual adjustment are located on the front side. The DC motor, electronic control unit, load-bearing section and maintenance-free gear unit are located in the housing. The actuator spindle and the column are made of rust-proof material. The inner printed circuit boards, gear unit and spring are made of steel. The valve spindle guide and the valve neck coupling are made of die-cast aluminium.

Note



With a media temperature of up to 110°C in the valve, an ambient temperature up to 60°C is permitted.

With a media temperature above 110°C, the ambient temperature must not exceed 55°C. Otherwise, the adapter 0372336180 must be fitted.

If there is a high media temperature in the valve, the actuator columns and the spindle can attain similarly high temperatures.

Auxiliary change-over contacts

0372333001 Switch rating max. 250 VAC, current min. 250 mA at 12 V (or 20 mA at 20 V)
 Switch rating max. 12...30 VDC, current max. 100 mA

0372333002 Switch rating max. 250 VAC, current min. 1 mA at 5 V
 Switch rating max. 0.1...30 VDC, current 1...100 mA

If it is used once over the range up to 10 mA or up to 50 V, the gold plating is eliminated. The switch can then only be used for a higher switch rating.

Coding switches

Characteristic selection

Desired character. curve	Switch coding	Characteristic curve for valve	Characteristic curve for drive	Effective on valve
Equal percentage				
Quadratic				
Linear				
Equal percentage				
Linear				
= factory setting				

Running time selection

Run time per mm	Switch coding	Run time for 14 mm stroke	Run time for 20 mm stroke	Run time for 40 mm stroke
2s		28s ± 1	40s ± 1	80s ± 4
4s		56s ± 2	80s ± 4	160s ± 4
6s		84s ± 4	120s ± 4	240s ± 8

= factory setting

Connection diagram

Continuous

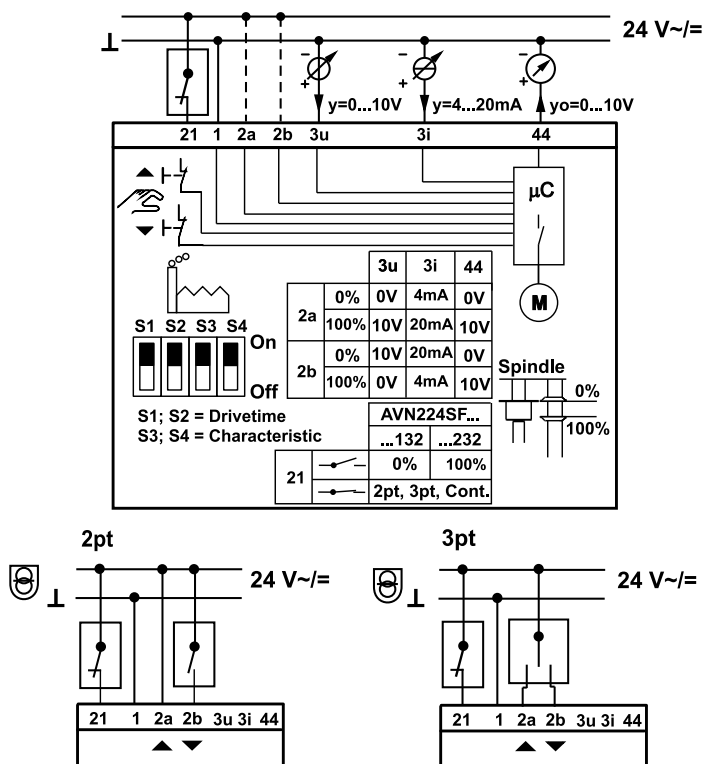

A110576B

Accessory connection

0313529001

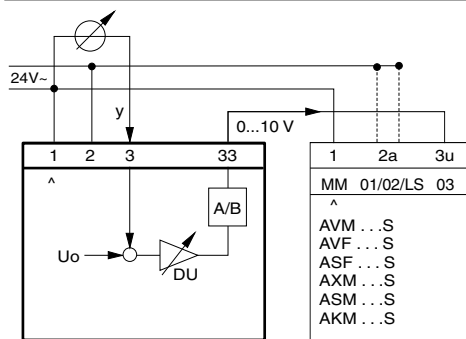

0372332001

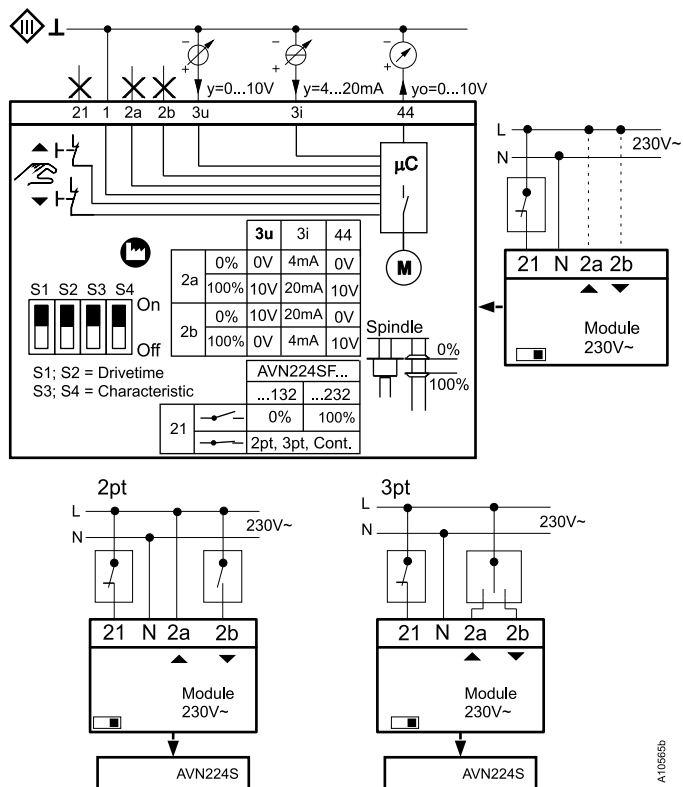

0372333001 and 0372333002

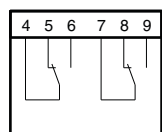

0372334001 and 0372334006

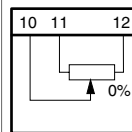

Dimension drawings

All dimensions in mm.

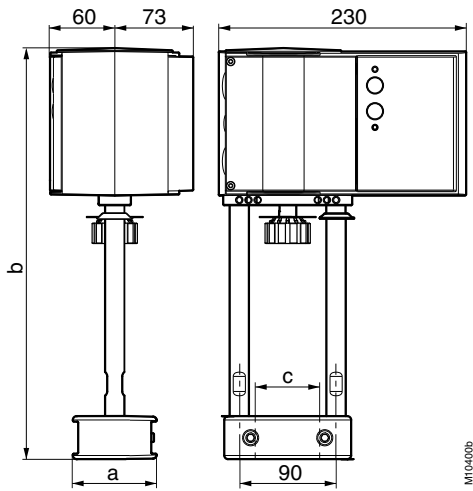

Type	a	b	c
AVN224SF132	64 mm	289 mm	44 mm
AVN224SF132-5	58 mm	289 mm	38 mm
AVN224SF132-6	78 mm	382 mm	60 mm
AVN224SF232	64 mm	289 mm	44 mm

Accessories

0372336 180
0372336 240

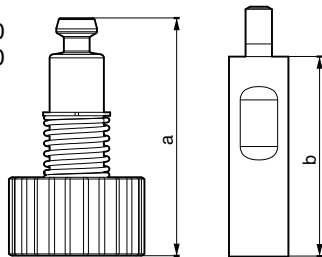

0372336	T (°C)	a (mm)	b (mm)
180	180	69,4	60
240	240	109,4	100